

2004 Parts & Accessories Catalog



Door Hardware Section

Cylinders, Handles, Latches,
Door Holders, Guides, Hangers,
Hinges, Rollers, Tracks, Wear Strips,
Regulators, Seals, Windows & Glass,
Roll-up Door Parts



MORGAN
★ OLSON

Cylinders

Make	Model	Year	Description	Individual Part #	Related Part #s
All	All Walk-in Models	All	Lock Cylinder w/key, for side & rear doors	1113383	1113014 Inner Mechanism
			Cylinder Removal Tool	1113384	for Cylinder 1113383 only



1113383



1113384

Make	Model	Year	Door Type	Shank Dimensions	Description	Individual Part #	Related Part #s
All	All	All	Rear Swing Open Door	N/A	Inner Handle	47000665	47000546 Mechanism
			Rear Roll-Up Door	.3125" x 2"	Locking "L" Handle	1115744	
			Rear Roll-Up Door	.3125" x 2"	Non-Locking "L" Handle	1116535	
			Rear Roll-Up Door	N/A	Lift Handle	1116536	
All	All Walk-in Models	1996 & prior	Rear Swing Open Door	.3125" x 3.75"	Handle with Stationary Cylinder Lock*	1112988	
			Rear Swing Open Door	.3125" x 3.75"	Locking Handle w/Push Lock	92913013	47000547 Mechanism 47006599 Latch
			Rear Swing Open Door	.3125" hole	Inner Handle	1113015	47000667 Mechanism 1113382 Outer Handle
			Rear Swing Open Door		Inner Handle	1113362	47000667 Mechanism 47000938 Outer Handle
All	All Walk-in Models	All	Bulkhead Door	N/A	Grab Handle	1113087	
			Rear Swing Open Door	.3125" x 3.75"	Non-Locking Handle	1113009	
			Rear Swing Open Door	.3125" x 3.75"	Handle with Socket for Push Lock Cylinder	1113382	1113383 Cylinder 47000667 Latch 1113015 Inner Handle
			Rear or Side Door	N/A	Door Handle Rubber Boot	44000254	for any Hook handle with key cylinder
			Side Sliding Door	.375" x 1.9375"	Non-Locking Handle	1113010	1113193 Latch

*With a Stationary Cylinder Lock, the driver must insert and turn the key to lock the handle.

Handles



1112988 Handle w/
stationary Lock & Key
1113009 Non-Locking
Handle (Shown)
1113382 Handle w/
socket for cylinder
92913013 Push Locking
Handle w/key & cylinder



1113010



1113015



1113087



1113362



1115744 Locking "L"
Handle, (Shown)
1116535 Non-Locking "L"
Handle



1116536



44000254



47000665

More Handles and Descriptions on next two pages.

Make	Model	Year	Door Type	Shank Dimensions	Description	Individual Part #	Related Part #s
All	All Walk-in Models	All	Side Sliding Door	.375" x 1.625"	Handle with Socket for Push Lock Cylinder	1113381	1113383 Cylinder 1113014 Latch
			Side Sliding Door	.375" x 1.875"	Handle with Socket for Push Lock Cylinder	1113393	1113383 Cylinder 1113014 Latch
			Side Sliding Door	.375" x 2"	Locking Handle w/Push Lock	92912999	1113014 Latch
			Side Swing Open Door	.3125" x 1.125"	Non-Locking Handle	1113420	1113298 & 1113299 Lock Kits
			Side Compartment Door	N/A	Paddle Handle w/Keys	1113378	
All	Kurbmaster	1977-1994	Side Swing Open Door	.3125" x 3.75"	Locking Handle w/Key	1113292	
All	Route Mate & Route Star current	1989-current	Side Sliding Door	.375" x 1.875"	Locking Paddle Style Handle w/Push Lock	47000795	1113014 Latch
			Side Sliding Door	.375" x 2"	Paddle Style Handle w/Socket for Push Lock Cylinder	47000912	1113383 Cylinder 1113014 Latch
			Side Sliding Door	.375" x 2"	Paddle Style Handle w/Socket for Push Lock Cylinder, Black	47000934	1113383 Cylinder 1113014 Latch
All	Route Star	1989-current	Rear Swing Open Door	.3125" x 1"	Handle with Socket for Push Lock Cylinder, Black	47000935	1113383 Cylinder 47000547 Mechanism 47006599 Latch
			Rear Swing Open Door	.3125" x 3.75"	Handle with Socket for Push Lock Cylinder, Black	47000938	1113383 Cylinder 1113424 Mechanism 1113015 Inner Handle

Handles, Continued



1113292 Locking Handle
w/key & cylinder
(Shown)
1113420 Non-locking
Handle



1113378



1113381 Handle
w/socket for
cylinder (Shown)
1113393 Handle
w/socket for
cylinder
92912999 Locking
Handle w/key &
cylinder

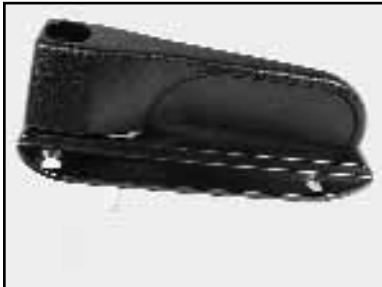

47000912 Stainless Steel
Handle w/socket for
cylinder
47000795 Stainless Steel
Locking Handle w/key &
cylinder
47000934 Black Handle
w/socket for cylinder
(Shown)



47000938



47000935

Make	Model	Year	Door Type	Dimensions	Description	Individual Part #	Related Part #s
All	All	All	Bulkhead Door	2.8125" Length	Finger Pull Latch	1113046	90187300 Handle
			Rear Swing Open Door	.3125" shank 2.5" x 6.25" overall	Center Mechanism	47000546	47000665 Handle
All	All Walk-in Models	1970-current	All Door Types		Dead Bolt Lock	1113364	
			Rear Roll-Up Door	.3125" shank	Slam Latch w/inside release	1116554	
			Rear Roll-Up Door	.875" x 5.8125"	Slam Latch Guide Pin	1116537	
			Rear Roll-Up Door		Standard Max. Security Lock w/Secondary Keeper	47009967	
			Rear Roll-Up Door		Safety Chain Lock Assembly	1116564	
			Rear Swing Open Door	3.5" Length	Slam Latch	1112010	1113024, 1113031 & 1113157 Rods
			Rear Swing Open Door	.3125" shank 2.4375" x 6.25" overall	Center Mechanism	1113424	1113426, 1113427, 1113428 & 1113429 Rods 1113015 Handle
			Rear Swing Open Door	.3125" shank 3" x 6.1875" overall	Center Mechanism	47000661	1112010 Latch 47000541 Cable
			Rear Swing Open Door	.3125" shank 2.625" x 8" overall	Center Mechanism	47000667	1113015 Handle 1113031 Rod
			Rear Swing Open Door		Lock Body Assembly	47000797	47006308 Cable 1112010 Latch 47000661 Mech.
			Rear Swing Open Door	.5" hole diameter	Rod Guide	1112011	1113029 Rod
			Rear Swing Open Door	24" Length*	Operating Rod, Upper, 72" Truck Height**	1113024	1112010 Latch

*Guideline for measuring rod length.

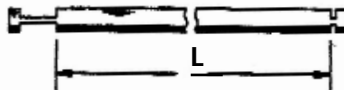

**See page 4 for guidelines to measure your truck's height.

Latch Hardware

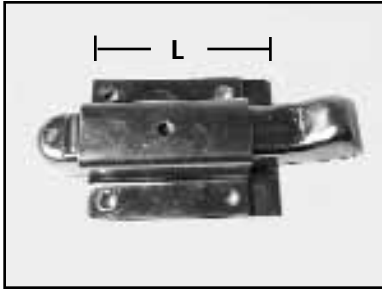

1112010



1112011



1113024

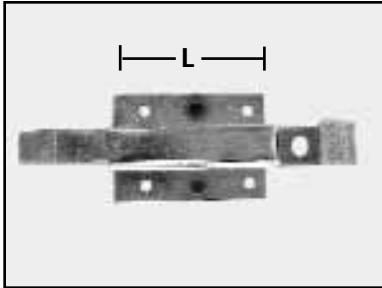

1113046



1113364

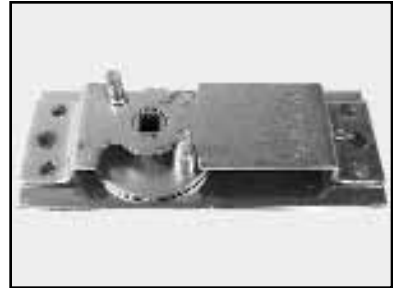

1113424
47000546



1116537



1116554

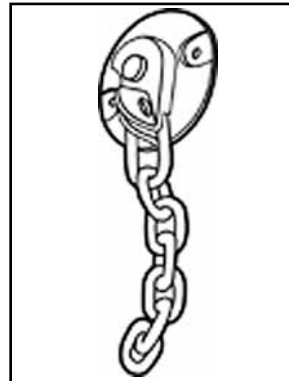

1116564

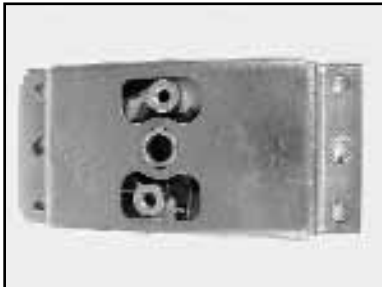

47000661



47000667



47000797

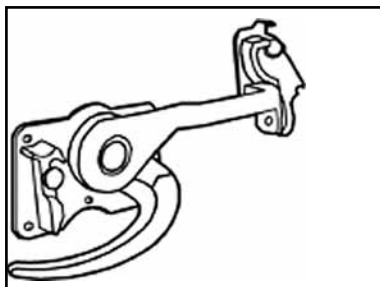

47009967

Continued on next page.

Latch Hardware, Continued

Make	Model	Year	Door Type	Dimensions	Description	Individual Part #	Related Part #s
All	All Walk-in Models	1970-current	Rear Swing Open Door	30" Length*	Operating Rod	1113029	1112011 Guide
			Rear Swing Open Door	32" Length*	Operating Rod, Upper, 80"/84" Truck Height**	1113031	1112010 Latch
			Rear Swing Open Door	24.6875" Length*	Operating Rod, Lower	1113157	1112010 Latch
			Rear Swing Open Door	32.625" Length*	Operating Rod, Lower	1113426	1113424 Mechanism
			Rear Swing Open Door	30.875" Length*	Operating Rod, Upper, 72" Truck Height**	1113427	1113424 Mechanism
			Rear Swing Open Door	38.625" Length*	Operating Rod, Upper, 80" Truck Height**	1113428	1113424 Mechanism
			Rear Swing Open Door	36.625" Length*	Operating Rod, Upper, 78" Truck Height**	1113429	1113424 Mechanism
			Rear Swing Open Door		Cable Assembly Kit	47000541	47000661 Mechanism 1112010 Latch
			Side Sliding Door	.375" shank	Inside Latch, 3" Doors	1113014	Handles: 1113381, 1113393, 92912999, 47000795, 47000912, 47000934
			Side Sliding Door	.375" shank	Inside Latch, 2.25" Doors	1113193	1113010 Handle
			Side Sliding Door		Forward Striker, Bronze	1102001	
			Side Sliding Door		Rear Striker, Bronze		
					Left Side	1102003	
					Right Side	1102002	
			Side Swing Open Door		Lock Kit		1113420 Handle
					Left Side	1113298	
					Right Side	1113299	

*Guideline for measuring rod length.

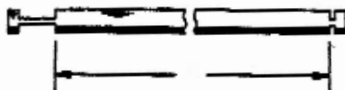

**See page 4 for guidelines to measure your truck's height.

Latch Hardware, Continued

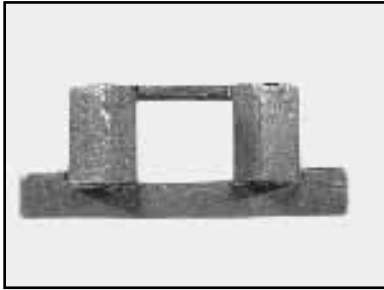

1102001

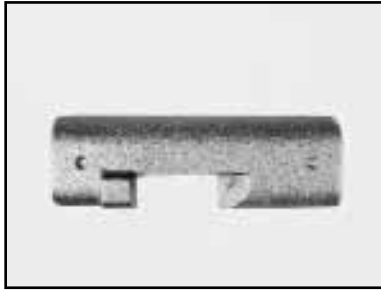

1102002
1102003



1113014



1113029
1113031
1113157



1113193

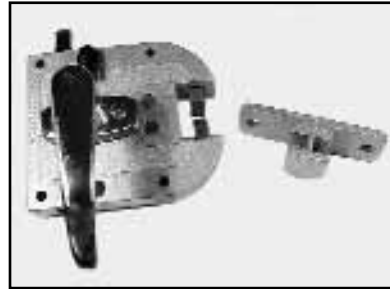

1113298 (Left)
1113299 (Right)



1113426
1113427
1113428
1113429

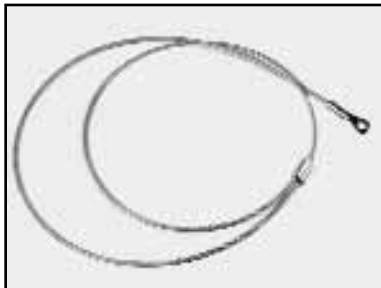

47000541

Continued on next page.

Latch Hardware, Continued

Make	Model	Year	Door Type	Dimensions	Description	Individual Part #	Related Part #s
All	Route Star	1989-current	Rear Swing Open Door	2.75" x 3.5" 31" Rod	Finger Pull Latch Kit	1113021	
			Side Sliding Door	4.3125" x 1.125"	Rear Striker	47000590	47000591 Mechanism
All	Route Mate & Route Star	1989-current	Bulkhead Door	2.625" x 5.9375" overall	Gate Latch	1113457	1113456 Lock Assembly
			Bulkhead Door	.3125" shank	Center Mechanism	47000547	
			Bulkhead Door		Lock Cylinder Assembly	1113456	1113457 Latch
		Rear Swing Open Door	.3125" shank	Center Mechanism Right Side	47000547	47006599 Latch	
				Center Mechanism Left Side	47000663		
		Rear Swing Open Door	3.063" Length	Slam Latch	47006599	47000547 Mechanism 47000663 Mechanism	
		1992-1995	Side Sliding Door		Forward Striker, Bronze	45100062	
1993-1995	Side Sliding Door	8.125" x 2.375"	Adjustable Striker, Forward & Rear, Bronze	45100093	45100094 Bracket		
			Striker Bracket	45100094	45100093 Striker		
Chevrolet	Route Mate	1989-current	Bulkhead Door		Striker Extension Assembly	91691203	
Chevrolet	Route Mate & Route Star	1989-current	Rear Swing Open Door	.5" x 7"	Bronze Striker	45100003	

Latch Hardware, Continued



1113021



1113456



1113457



45100003



45100062

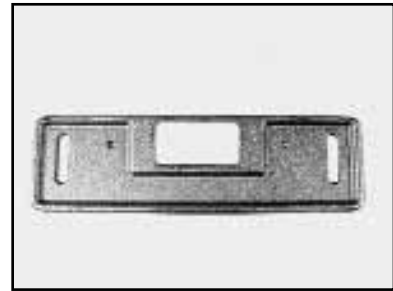

45100093



45100094

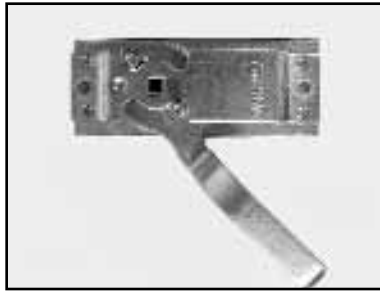

47000547
47000663

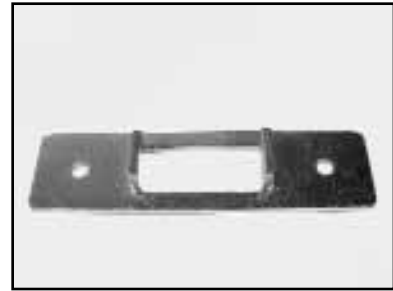

47000590

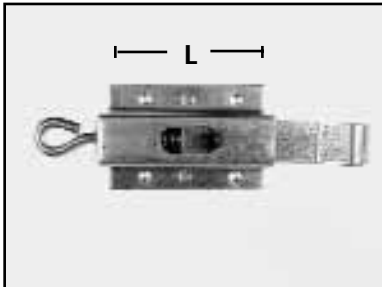

47006599



91691203

Make	Model	Year	Description	Dimensions	Individual Part #	Related Part #s
All	All Walk-in Models	All	Rubber Insert for Hold Back Socket	1.625" overall diameter	1107086	Socket1113037
			Hold Back Plunger	(add .375" to shaft for overall length) 2.25" shaft 1.25" shaft 2.75" shaft	1113036 1113038 1113437	Socket1113037 Socket1113037 Socket1113037
			Hold Back Socket w/insert		1113037	Plungers 1113036, 1113038 & 1113437
			Socket & Plunger	3.25" c to c (socket), 1.625" c to c (plunger)	1113035	
			"T" Hold Back	4" hook	1113094	Holder 1113095
			"T" Holder		1113095	Hold Back 1113094
			Door Stop Assembly		5903152	
All	Route Mate	All	Hold Back	1.625" dia.	47000921	

Door Holders



1107086



1113035



1113036
1113038
1113437



1113037

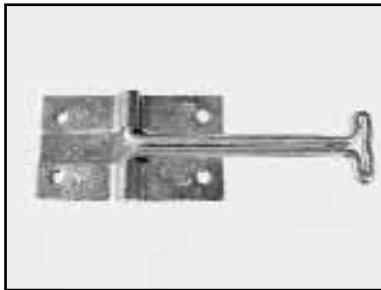

1113094



1113095



47000921



5903152



1100846



47002766



7908356

Make	Model	Year	Description	Dimensions	Individual Part #	Related Part #
All	All Walk-in Models	1970-current	Door Guide Casting, Bulkhead Door	3" x 1"	1100846	
			Lower Door Guide, Side & Bulkhead Doors	51.375" Length	47002766	
Chevrolet	Route Star	1989-current	Door Guide, Bulkhead Door	25" Length	7908356	Lower Tracks 77988065 & 91691307

Hangers

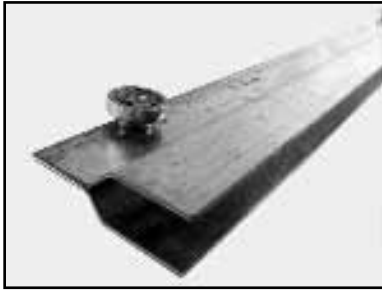

1101322
1101373

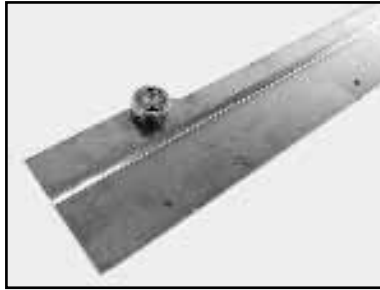

83554904

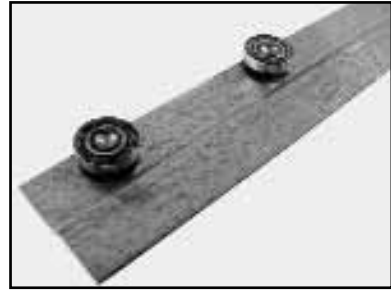

91691308



96335251



96343201
998543200

Make	Model	Year	Description	Dimensions	Part#
All	Route Star	1989-current	Bulkhead Door Hanger	31" Length, .75" Gap	1101373
			Bulkhead Door Hanger	27.375" Length	96335251
Chevrolet	All Walk-In Models	1978-1995	Side Door Hanger	36.5" Length	83554904
Chevrolet	Route Mate	1989-current	Bulkhead Door Hanger	24.625" Length	91691308
Chevrolet/Workhorse	Route Star	1989-current	Bulkhead Door Hanger	26" Length, .75" Gap	1101322
			Bulkhead Door Hanger	25.75" Length	77988320
		1998-current	Side Door Hanger	36.5" Length	96343201
			Side Door Hanger	39.92" Length	998543200



1100954



1113060

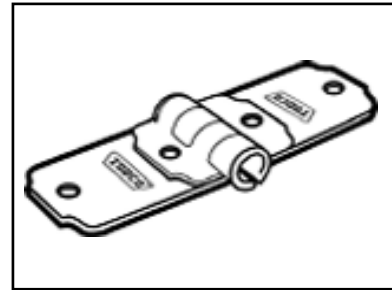

1115764

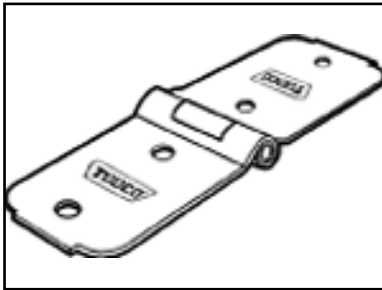

1116533

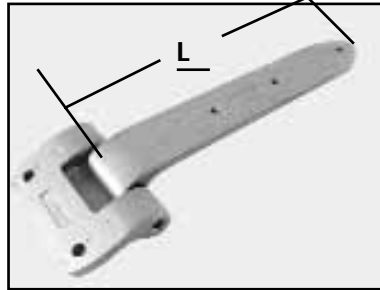

47007897

Make	Model	Year	Description	Dimensions	Part #
All	All Walk-in Models	1970-current	Rear Door Hinge Spacer		1100954
			Rear Door Piano Hinge	2.1875" x 76.375"	1113060
			Standard End Hinge, Rear Roll-up Door		1115764
			Standard Center Hinge, Rear Roll-up Door		1116533
			Rear Door Strap Hinge, with grease fitting	12" Length from center of pin to end of hinge strap	47007897

Rollers

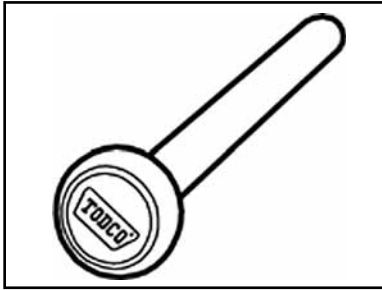

1115742 (Standard)
47009916 (Sealed)

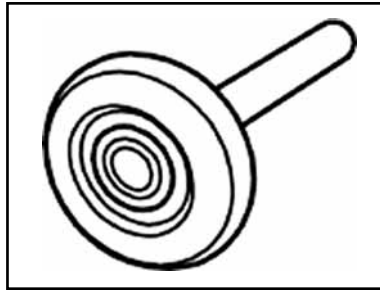

47000822



5600056

Make	Model	Year	Description	Part #
All	All	All	1" Steel Roller, Rear Roll-Up Door Standard	1115742
			Sealed	47009916
			2" Steel Roller, Rear Roll-Up Door	47000822
All	Kurbmaster	1970-1980	Roller Wheel Assm., Side Door	5600056



84342005
89121200
91691200



77988065
91691307

Make	Model	Year	Description	Dimensions	Individual Part #	Related Part #
All	All Walk-ins except Kurbmaster	1989-current	Upper Track Assembly, Right & Left Side Doors	69" Length	89121200	
All	Kurbmaster	1970-1995	Upper Track Assembly, Right & Left Side Doors	69" Length	84342005	
Chevrolet	Route Mate	1989-current	Lower Track, Bulkhead Door	28" Length	91691307	Guide 7908356
			Upper Track Assembly, Bulkhead Door	49.75" Length	91691200	
Chevrolet	Route Star	1989-current	Lower Track, Bulkhead Door	25" Length	77988065	Guide 7908356

Wear Strip



90566304



96366304



998560311

Make	Model	Year	Dimensions	Description	Part #
All	All Walk-in Models	1970-current	.6875" x 40"	Wear Strip, Side Door	90566304
All	Route Star	1999-current	29.25" Length	Wear Strip, Side Door	
				Left	998560311
				Right	998560312
Chevrolet	Route Star	1989-current	24.875" Length	Wear Strip, Side Door	96366304

Make	Model	Year	Dimensions	Description	Individual Part #	Related Part #s
All	Walk-ins except Route Mate	1970-1993	24" Lift, 29.5" Length	Window Regulator, 2 pt. chain driven	47007514	47007508 Crank 1112984 Channel
All	All Walk-in Models	1970-current		Window Crank Handle	47007508	
			17.375" x 1.5"	Channel Setting Tape	47007523	
		1970-1990	25.75" Length	Window Regulator, 3 pt. chain driven		47007508 Crank 1112984 Channel
				Right	47007515	
				Left	47007516	
			23" Length	Glass Channel	1112984	
		1990-1999		Window Regulator	47007520	
			17.375" Length	Regulator Channel	47007521	47007520 Regulator
		1990-current		Regulator Handle & Screw	47007522	47007520 Regulator
			4.8125" Length	Regulator Guide Rubber	45200062	47007520 Regulator
All	Kurbmaster	1970-1993	28.5" length	Window Regulator, 3 pt. chain driven	47007504	47007508 Crank 1112984 Channel
All	Route Star	1999-current		Window Regulator, for 31" & 35" doors		
				Left	47007526	
				Right	47007527	
			25" Length	Glass Channel for 31" doors	47007530	
			17.6875" Length	Glass Channel for 35" doors	47007532	

Regulators

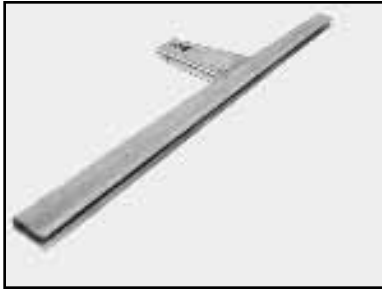

1112984

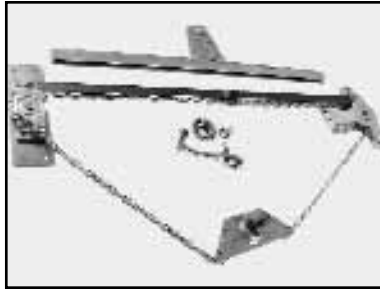

47007504



47007508

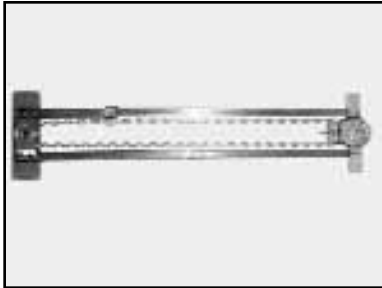

47007514

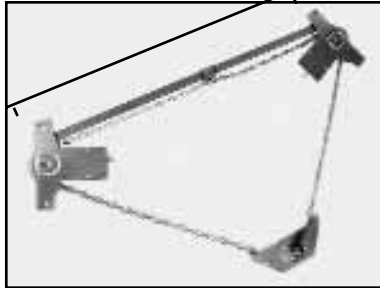

47007515
47007516

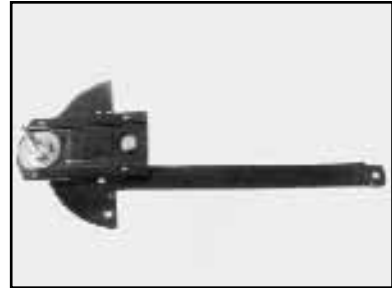

47007520



47007521



47007522



47007523

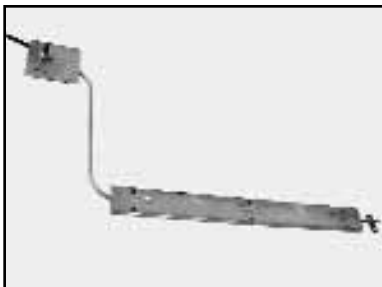

47007526
47007527



47007530

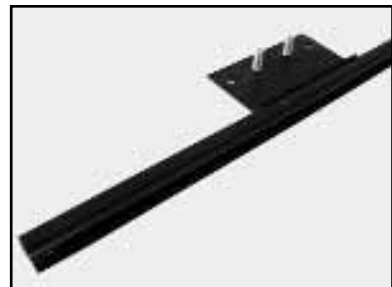

47007532



45200062

Make	Model	Year	Door Type	Dimensions	Description	Part #
All	All Models current	1970-Door	Rear Roll-Up		Side Seal Assembly	1115746
			Rear Roll-Up Door		Rubber Side Seal	47000806
			Rear Roll-Up Door		Head Seal (Header Mounted)	47000839
			Rear Roll-Up Door		1" Brush Seal	47000899
			Rear Roll-Up Door		Four-Prong Bottom Seal	47001467
			Rear Roll-Up Door		Head Seal (Panel Mounted)	47009914
All Models	All Walk-in	1970-current	Rear Door	25 ft. section	Sponge Seal	003399401
			Side Door	83" Length	Rear Seal	1107142
			98.5" Length	Glass Channel	Felt	1129001
All	All Kurbmasters	1970-1995	Side Door	78" Length	Forward Seal	1107147
All	All Walk-ins except Kurbmaster	1989-current	Side Door Length	72.8125" Seal	Type B Brush	44000064
			Side Door Length	76.875" Seal	Type B Brush	44000062
			Side Door Length	82.1875" Seal	Type C Brush	44004060
			Side Door	95" Length	Rubber Seal	44004107

Seals



003399401



1107147

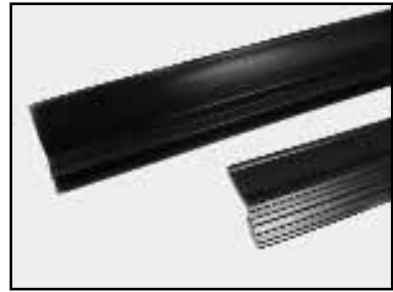

1107142



1129001

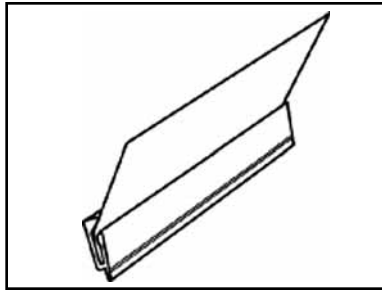

1115746



44000062
44000064
44004060



44004107

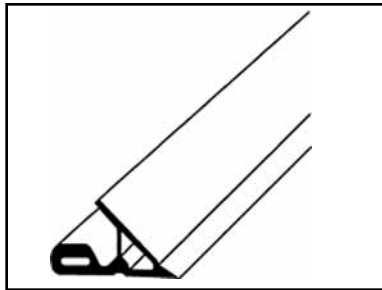

47000806

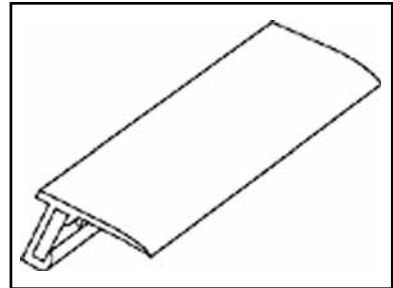

47000839



47000899

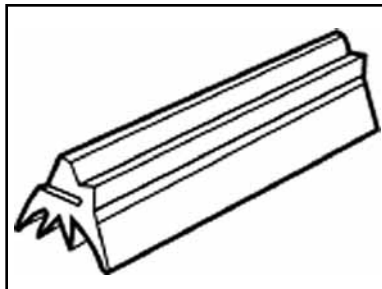

47001467

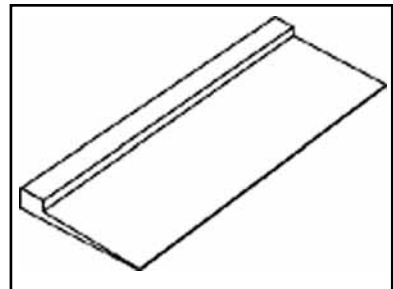

47009914

Make	Model	Year	Dimensions (Height x Width)	Description	Individual Part #	Related Part #s
All	All	All	19.875" x 13.625"	Rear Door Glass	1110033	
All	All Walk-in Models	1970-1993	23" x 28.18"	Roll-up Window, Side Door	1110032	
		1993-1997	23" x 28.06"	Roll-up Window, Side Door	45800021	
All	All Walk-ins except Route Mate	1970-current	25.625" x 27.75" (Window Opening)	Sliding Sash Side Window Right Left		1113183 Latch 1110159 1110161
			Sliding Sash Window Latch	1113183		1110159 & 1110161 Windows
All	All Walk-ins except Kurbmaster	1989-current	19.75" x 26.75" (Window Opening)	Sliding Sash Side Window Right Left	45800040 45800041	
			.07" x 2" x 28.75"	Filler Strip	91900527	45800040 & 45800041 Windows
		1990-current	23" x 28.06"	Roll-up Window, Side Door, tinted	45800059	
All	Route Star	1999-current	28.43" x 32.59"	Roll-up Window, Side Door	45800081	
			23.93" x 32.59"	Roll-up Window, Side Door	45800084	

Windows and Glass

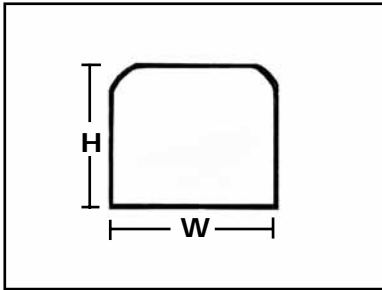

1110032, 45800021,
45800059, 45800081,
45800084

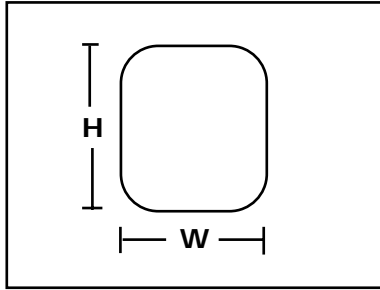

1110033

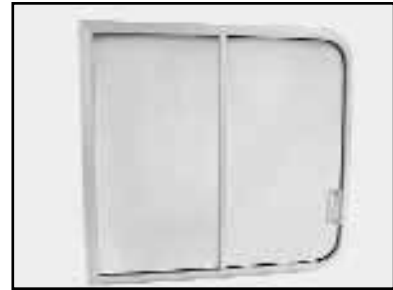

1110159
1110161



1113183



45800040
45800041



91900527

Item	Description	Item	Description
1	Vertical Track Assembly - LH (Curbside) Vertical Track Assembly - RH (Roadside)	32	Keeper Assembly
5	Bearing Assembly	33	Lift Handle
7	Cable Drum - RH (Roadside)	36	Pull Strap Retainer
8	Spring Anchor Bracket	37	Pull Strap - 12" Looped (Standard)
9	Spring Anchor Plug	38	Catch Box
10	Spring	41	Cable Anchor Bracket
11	Spring Winding Plug	42	Cable Anchor Pin
12	Bearing Assembly - Support Bracket	43	Bottom Seal
13	Support Bracket - LH (Curbside)	44	Bottom Angle
14	Cable Drum - LH (Curbside)	45	Bottom Fixture
15	Counterbalance Shaft	46	Roller
16	Filler Plug	47	Spacer Washer - Roller
17	Horizontal Track - LH (Curbside) Horizontal Track - RH (Roadside)	48	End Hinge Assembly
22	Retainer - Head Seal (Header Mounted)	50	Center Hinge Assembly
23	Head Seal (Header Mounted)	51	Base - Adjustable Top Fixture
24	Retainer - Head Seal (Panel Mounted)	52	Slide - Adjustable Top Fixture
25	Head Seal (Panel Mounted)	55	Cable Assembly - LH (Curbside) - Inside Cable Cable Assembly - RH (Roadside) - Inside Cable
26	Top Panel - Plastic - No Hardware Top Panel - Aluminum Covered - No Hardware	56	Spacer Washer - Cable Drum
27	Intermediate Panel - Plastic - No Hardware Intermediate Panel - Aluminum Covered - No Hardware	57	Vertical Track Assembly - LH (Curbside) Vertical Track Assembly - RH (Curbside)
28	Bottom Panel - Plastic Bottom Panel - Aluminum Covered	58	Bearing
31	Maximum Security Lock Assembly - Standard Maximum Security Lock Assembly - Offset Lever Arm	59	Cable Assembly
		60	Side Seal - Pair
		61	Cable Drum - LH (Curbside)
		62	Cable Drum - RH (Roadside)
		63	Head Seal Assembly (Header Mounted)
		64	Head Seal Assembly (Panel Mounted)

NOTE: Item numbers are not actual part numbers. Please call our customer service representatives for assistance. For quicker service, have your truck's Body I.D.#, the Serial # from your roll-up door and a description of the part ready when calling. If ordering panels, please obtain the size and location of the panels.

Todco Roll-Up Door

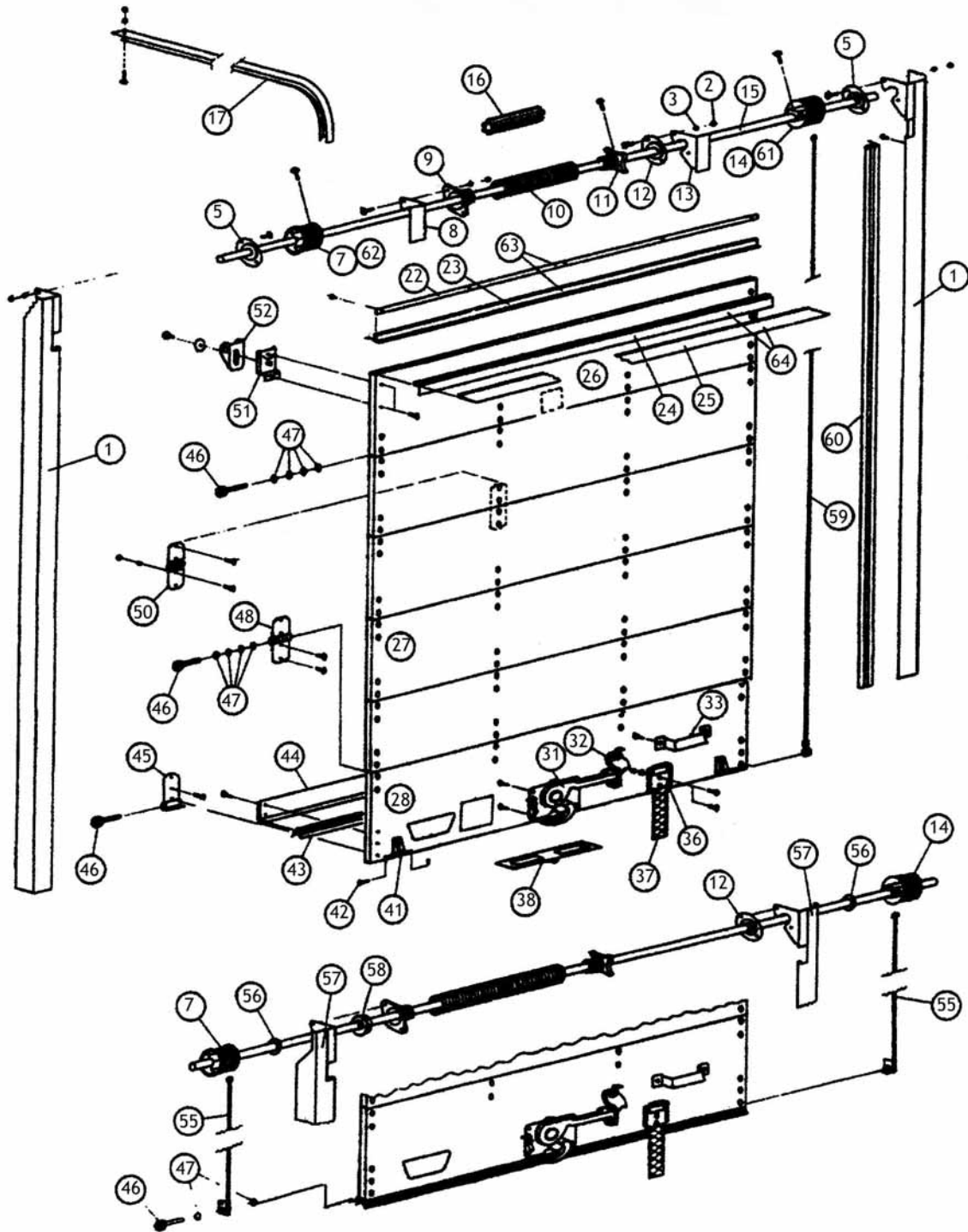

NOTE: The Roll-up door serial number is required to order roll-up door parts. It is located on the inside of the door on the second panel from the top on an aluminum plate.



2004 Parts & Accessories Catalog

1-800-233-4823 • www.morganolsonparts.com • parts@morganolson.com



1801 South Nottawa Road
Sturgis, MI 49091
1-800-233-4823 (Parts)
800.624.9005 • 269.659.0200
269.651.4259 fax
Email: parts@morganolson.com
www.morganolsonparts.com
www.morganolson.com

At Morgan Olson, our quest for quality and safety is ongoing and therefore the specifications on the product described herein may vary over time.
Please contact Morgan Olson for the latest product information and available safety features and options.

© 2004 Morgan Olson Corporation.